

Notice de montage

2 - faire correspondre les perçages des tablettes avec ceux des plateaux: boulonner

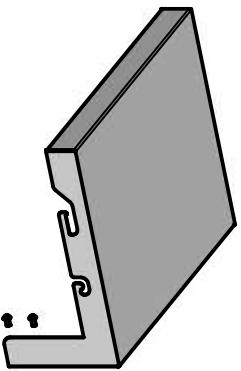

1 - faire correspondre les perçages des montants avec ceux des plateaux: boulonner

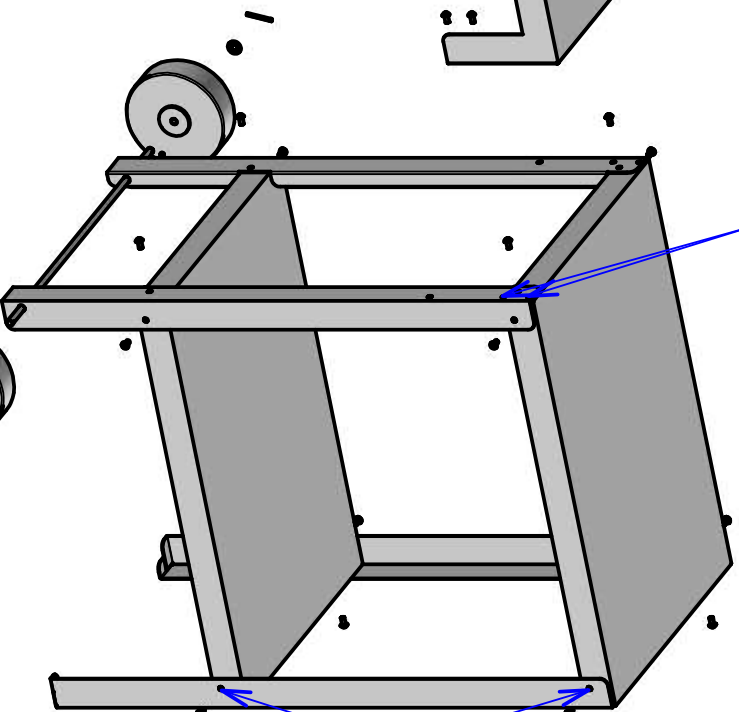
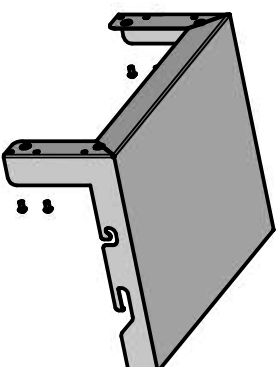

3 - roue + rondelle + goupille de sécurité à monter dans l'ordre sur l'axe: écarter la goupille

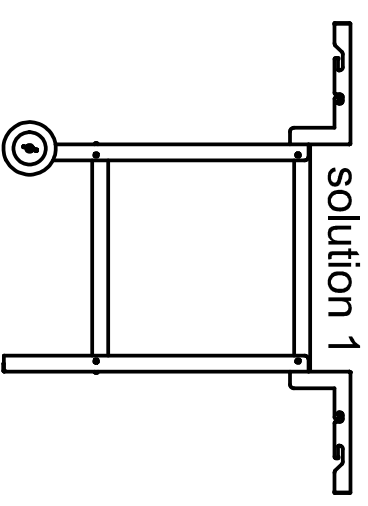
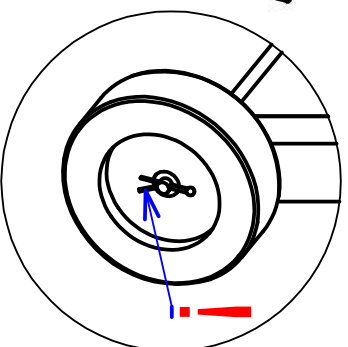
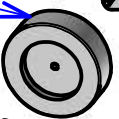

solution 1

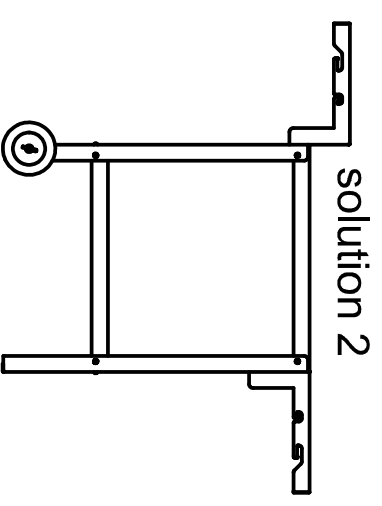

solution 2

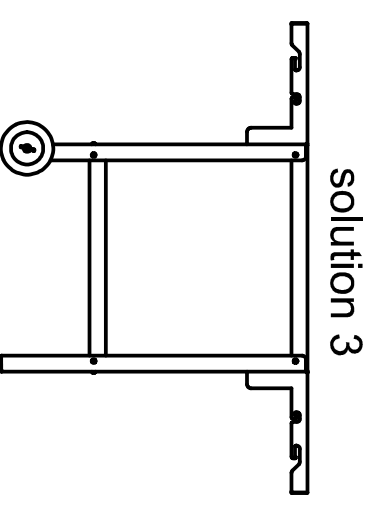

solution 3